

Ventil-Stellantrieb
 Valve servo drive
 Actionneur de vanne
 Posicionador de válvula
 Klepregelaaandrijving
 Attuatore a valvola
 Ventiltanöverdon
 Ventilový servopohon
 Napęd nastawnika zaworu
 Сервопривод клапана
 Szelep-beállító
 阀门调节驱动

de Montagehinweis
 en Mounting instructions
 fr Instructions de montage
 es Indicaciones de montaje
 nl Montage-instructie
 it Istruzioni di montaggio
 sv Montageanvisning
 cs Pokyny pro montáž
 pl Instrukcja montau
 ru Указание по монтажу
 hu Szerelési útmutató
 zh 安装提示

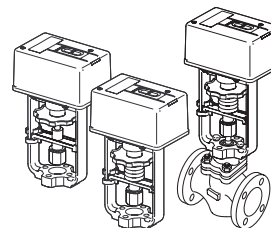

Technik mit Zukunft.
 DEUTSCHE QUALITÄTSARMATUREN



ARI-PACO
0,85 D / 0,85 Y

0040506003 3310

ARI-PACO

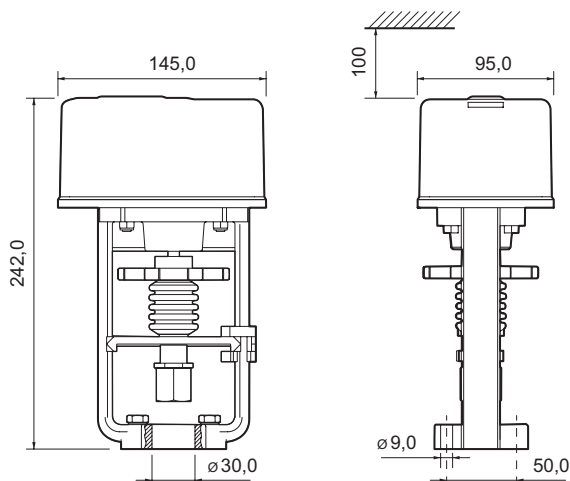

GEFAHR! Elektrische Spannung 230V.

DANGER! Electrical voltage 230V.

DANGER! Tension électrique 230V.

¡PELIGRO! Tensión eléctrica 230V.

GEVAAR! Elektrische spanning 230V.

PERICOLO! Tensione elettrica 230V.

FARA! Elektrisk spänning 230V.

NEBEZPEČÍ! Elektrické napětí 230V.

NIEBEZPIECZEŃSTWO! Napięcie elektryczne 230V.

ОПАСНОСТЬ! Электрическое напряжение 230В.

VESZÉLY! Elektromos feszültség 230V.

危険 电压 230V.



ACHTUNG! Montage und Installation darf nur durch qualifiziertes Fachpersonal vorgenommen werden.

NOTICE! Assembly and installation may only be carried out by qualified specialist personnel.

ATTENTION! Le montage et l'installation doivent uniquement être effectués par du personnel qualifié.

¡ATENCIÓN! El montaje y la instalación sólo lo puede realizar personal técnico calificado.

LET OP! Montage en installatie mogen slechts door geschoold personeel met de nodige kwalificatie worden uitgevoerd.

ATTENZIONE! Fare svolgere i lavori di montaggio e installazione solo da parte di personale qualificato.

VARNING! Montage och installation får endast ske av kvalificerad fackpersonal.

POZOR! Montáž a instalaci smí provádět pouze kvalifikovaný odborný personál.

UWAGA! Montaż i instalację mogą przeprowadzać tylko wykwalifikowani specjaliści.

ВНИМАНИЕ! Монтажи и установка должны производиться только квалифицированным техперсоналом.

FIGYELEM! A szerelést és telepítést csak szakképzett személyek végezhetik.

注意 安装工作只能由具备相应资质的专业技术人员进行。

Änderungen vorbehalten - Contents subject to change - Sous réserve de modifications - Reservado el derecho a modificación - Wijzigingen voorbehouden - Con riserva di modifiche - Imnehåll som skall ändras - Zmny vyhrazeny - Zmiany zastrzeżone - Возможны изменения - A változtatások jogát fenntartjuk - 保留未经通知而改动的权力

ARI-PACO 0,85 D / 0,85 Y

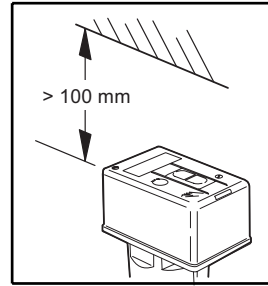
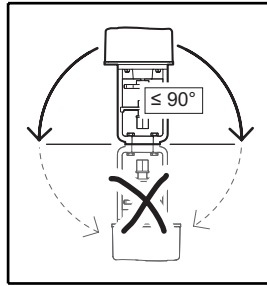
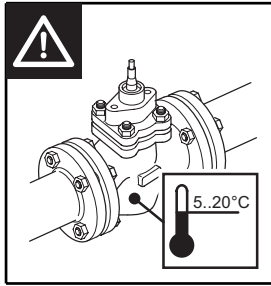
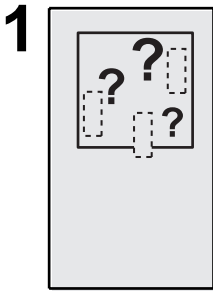

IP54
0..50 °C
 Luftfeuchte nicht kondensierend
 Non-condensing humidity
 Humidité relative, non condensée
 Humedad de aire no condensado
 Luchtvochtigheid niet condensierend
 Umidità aria non condensante
 Ej kondenserande luftfukighet
 Nekondenzující vlhkost vzduchu
 Niekondensujúca wilgtoćność powietrza
 Влажность воздуха без конденсации
 Nem kondenzáló páratartalom
 不产生蒸气

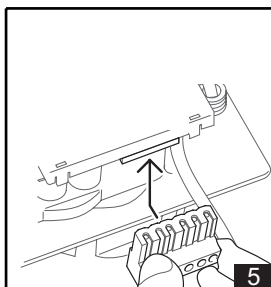
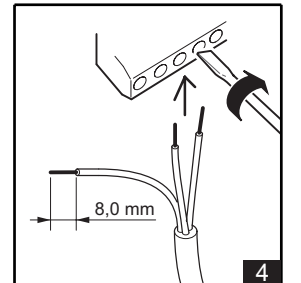
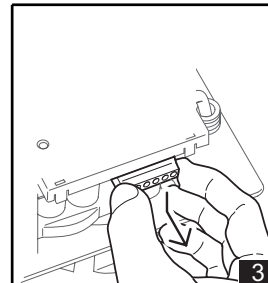
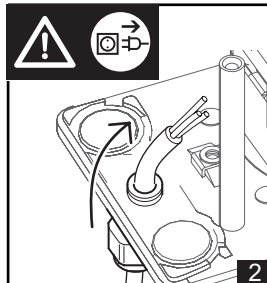
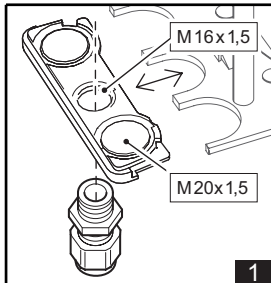
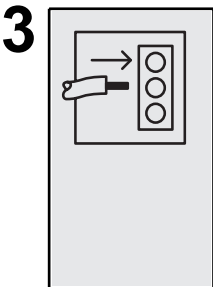
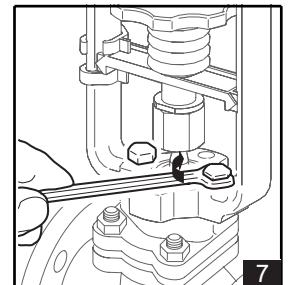
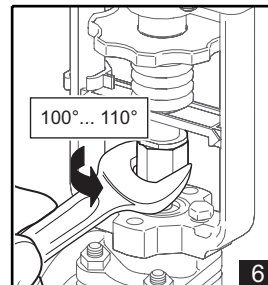
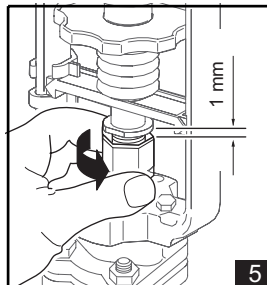
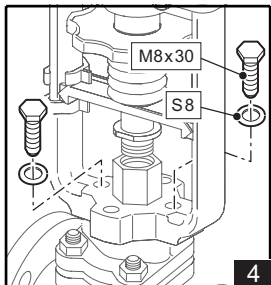
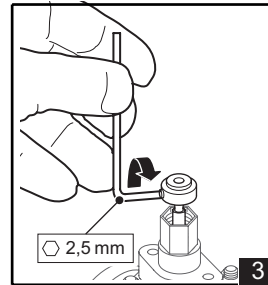
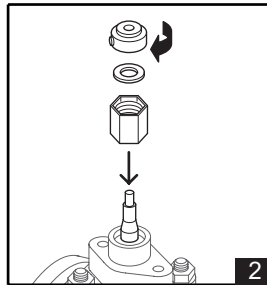
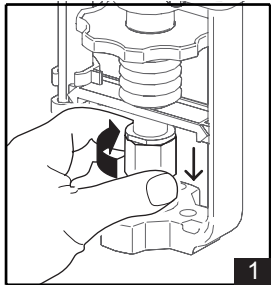
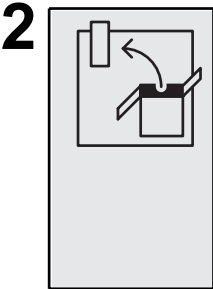

ARI-PACO 0,85Y

V 1 0 Y A 0 0 M 3 2

24V~ 0V R y

ARI-PACO 0,85D

3 2 1

L1 N PE

(24V) (0V)

